

Installation and Operation Instructions

Differential-Pressure Flow Meter DDM-EM



Inhaltsverzeichnis

1	Foreword	4
2	Safety	4
2.1	Symbol and meaning	4
2.2	General safety directions and exemption liability	4
2.3	Intended use	4
2.4	Information for operator and operating personnel.....	5
2.5	Regulations and guidelines	5
2.6	Notice as required by the hazardous materials directive	5
3	Transport and storage	5
4	Installation	5
4.1	Preparatory work prior to installation.....	5
4.2	DDM-EM with screws connection	6
4.3	DDM-EM mounted between flanges	7
4.4	DDM-EM inside thread	8
4.5	Electrical connection	9
5	Start-up	10
5.1	Display	10
5.2	Setup	11
5.2.1	Keyboard	11
5.3	Menu levels	12
5.3.1	Menu Level Switch points.....	13
5.3.2	Menu Level Input.....	15
5.3.3	Menu Level Measuring	16
5.3.4	Menu Level Output	17
5.3.5	Menu Level Function	18
5.3.6	Menu Level Display	21
5.3.7	Menu Level System.....	25
6	Service	26
7	Disposal	26
8	Technical data	27
8.1	Technical data display unit EM	27
8.1.1	Programming display unit EM	28
8.1.2	Connections	28
8.2	Type series	28
8.3	Technical data of orifice	29
8.3.1	Connection	29
8.3.2	Materials.....	29

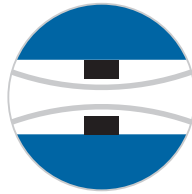

DDM-EM

Differential pressure flow meters

8.4	Dimensions	30
8.4.1	Dimensions for DDM-EM DN	30
8.4.2	Dimensions for DDM-EM Rp	30
8.4.3	Dimensions for DDM-EM Gi/Ga	30
8.5	Measuring ranges	32
8.5.1	Water	32
8.5.2	Air	33



1 Foreword

These Installation and Operating Instructions are applicable to Series DDM-EM devices. Please follow all instructions and information given for installation, operation, inspection and maintenance. The Instructions form a component part of the device and should be kept in an appropriate place accessible to personnel in the vicinity of the location. Where various plant components are operated together, the operating instructions pertaining to the other devices should also be observed.

2 Safety

2.1 Symbol and meaning



Safety notice

This symbol is placed against all directions/information relating to occupational health and safety in these Installation and Operating Instructions and draws attention to danger to life and limb. Such notices should be strictly observed.

2.2 General safety directions and exemption liability

This document contains basic instructions for the installation, operation, inspection and maintenance of the variable area flow meter. Non-observance of these directions can lead to hazardous situations for man and beast and also to damage to property, for which Kirchner und Tochter disclaims all liability.

The operator is required to rule out potentially hazardous situations through voltage and released media energy.

2.3 Intended use

The DDM-EM differential-pressure flow meters are designed for measuring and monitoring the flow of liquids and gases. They may be installed in the pipeline only between flanges or using threaded pipe connections. Straight, unimpeded lengths of pipe runs must be a minimum of 6 x DN upstream of the location and a minimum of 4 x DN downstream of the location. The required version of the DDM-EM device should be selected on the basis of the nominal diameter and nominal pressure at the location as well as the type of medium.

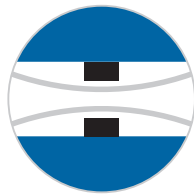

2.4 Information for operator and operating personnel

Authorized installation, operating, inspection and maintenance personnel should be suitably qualified for the jobs assigned to them and should receive appropriate training and instruction. All persons charged with assembly, mounting, operation, inspection and maintenance duties must have read and understood the operating instructions. Gaskets in contact with the fluid product must be replaced after all maintenance and repair work.

2.5 Regulations and guidelines

In addition to the directions given in these Installation and Operating Instructions, observe the regulations, guidelines and standards, such as DIN EN and for specific applications, the codes of practice issued by DVGW (gas and water) and VdS (underwriters) or the equivalent national codes and applicable national accident prevention regulations.

2.6 Notice as required by the hazardous materials directive

In accordance with the law concerning handling of waste (critical waste) and the hazardous materials directive (general duty to protect), we would point out that all flow meters returned to Kirchner und Tochter for repair are required to be free from any and all hazardous substances (alkaline solutions, acids, solvents etc.).



Make sure that devices are thoroughly rinsed out to neutralize hazardous substances.

3 Transport and storage

Always use the original packing for transport, handling and storage. Protect the device against rough handling, coarse impact, jolts etc.

4 Installation

4.1 Preparatory work prior to installation

Provide the pipe ends at the installation point with the external pipe thread or flanges respectively (Type series DN) appropriate to the device. Make sure the installation space at the installation point is in keeping with the dimensions given in the dimensional drawing and the table in the Technical Data chapter



4.2 DDM-EM with screws connection

The measuring device is screwed into the pipeline between two inserts that are supplied with the device. The straight, unimpeded inlet and outlet runs should be a minimum of 6 x DN upstream and a minimum of 4 x DN downstream of the location. Between the inserts, leave a gap of $L1 + 4$ mm for the gaskets. The dimensions of $L1$ can be in section 8.4.

- Cut appropriate threads on the pipe ends (3) (in accordance with the order). Make sure that the ends of the pipe are in alignment.
- Unscrew the union nuts (1) from the DDM-EM (2) and slide these on to the pipe ends, with the thread facing towards the device (2).
- Screw the inserts (4) to the pipe ends using suitable packing material.

Inaccurate measurements are possible due to incorrect installation position. Observe the flow direction during installation [see arrow on the device (6)]

- Position the DDM-EM together with the two gaskets (5) between the pipe ends/inserts (3/4) and tighten the union nuts (1).

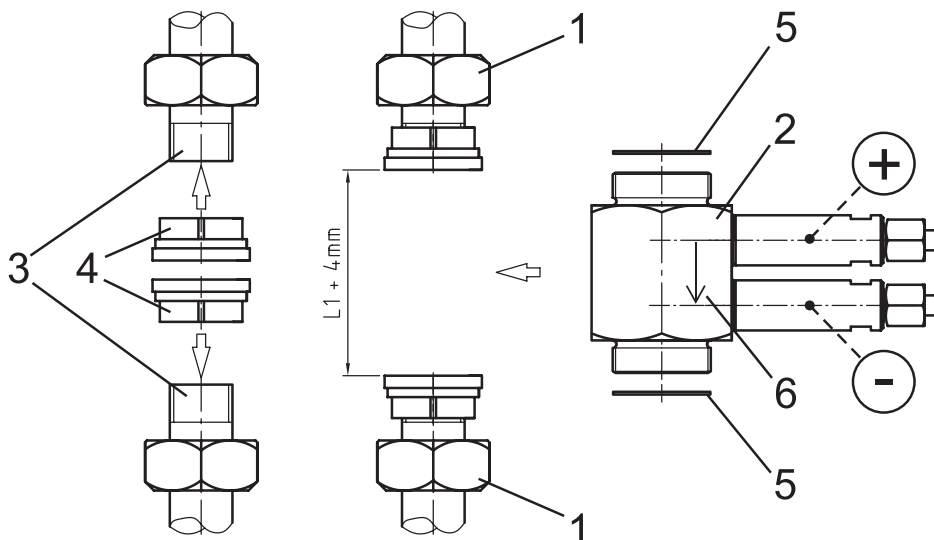

1. Union nut
2. DDM
3. Pipe ends (customer side)
4. Inserts
5. Gaskets
6. Arrow for installation direction

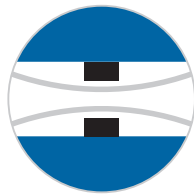

4.3 DDM-EM mounted between flanges

The flow meter is mounted between flanges to DIN EN 1092-1 (Type 11 or Type 13). The straight, unimpeded pipe run should be a minimum of 6 x DN upstream and a minimum of 4 x DN downstream of the location. The distance between the flanges should be 55 mm for the ring plus twice the thickness of the gaskets to be used. Make sure that the flanges are in alignment and the sealing faces are parallel to each other. Check that the flanges at the location agree with the details given in the order (standard and pressure rating).

- The distance between the flanges should be at least $55 \text{ mm}^* + 2 \times t$ (thickness of gaskets used).
- Fit half of the screw connections to the interflange connection.
- Mount the orifice, together with the gaskets fitted on both sides, between the two prepared flanges.
- Assemble the remaining screw connections.
- When tightening the screws, make sure that orifice and gaskets are concentric and in alignment with the pipeline.
- Fasten all screw connections uniformly in diagonally opposed sequence.

*(Standard length)
Length can vary order related.
Please compare with your order!

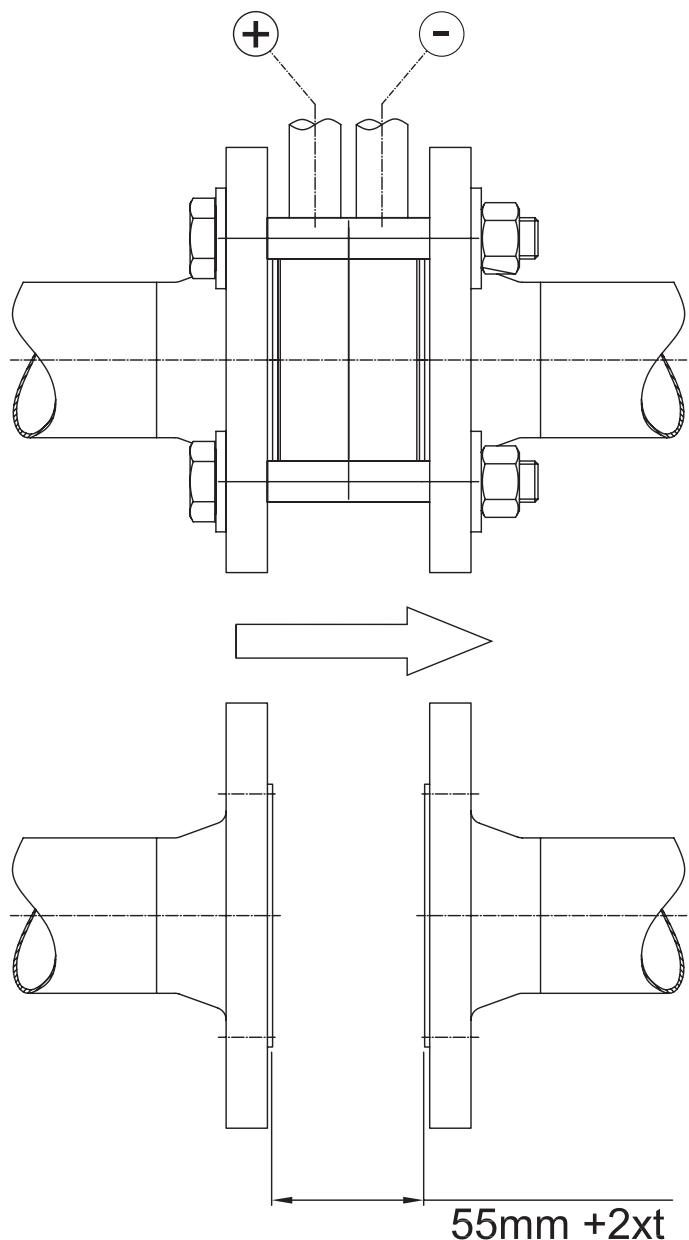



4.4 DDM-EM inside thread

The measuring device is screwed into the pipeline. The straight, unimpeded inlet and outlet runs should be a minimum of 6 x DN upstream and a minimum of 4 x DN downstream of the location. Between the inserts, leave a gap of $L1 + 4$ mm for the gaskets. The dimensions of L1 can be found in section 8.4.

- Cut appropriate threads on the pipe ends (in accordance with the order). Make sure that the ends of the pipe are in alignment.
- Screw the device to the pipe ends using suitable packing material.



Pay attention to the direction of flow (see arrow on the device).

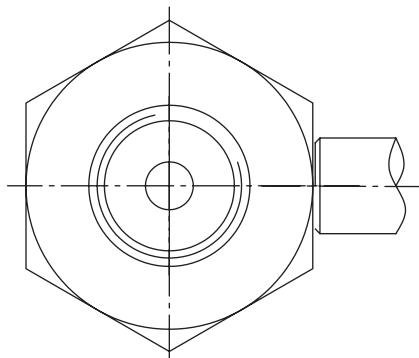
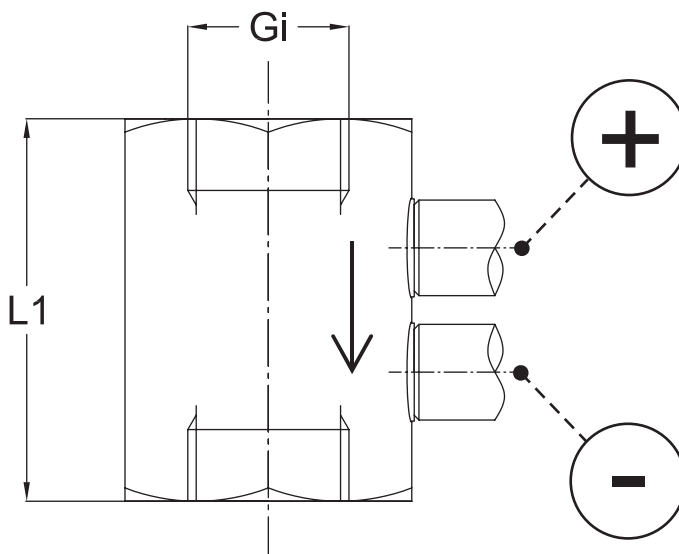

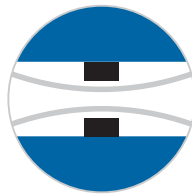

4.5 Electrical connection

- By authorized and qualified specialized personnel only.
- When connecting the unit, the national and international electrotechnical regulations must be observed.
- Disconnect the system from the mains, before electrically connecting the device.
- Install the consumer-adapted fuses.
- Do not connect the connector if strained.

The nominal supply voltage and the permissible range as well as the permissible load/load are specified in the technical data section 8.1.

Note: During assembly, ensure that the connection to the system earth is realised via the process connection.

3-wire connection

The device is connected as follows in a 3-wire switch:

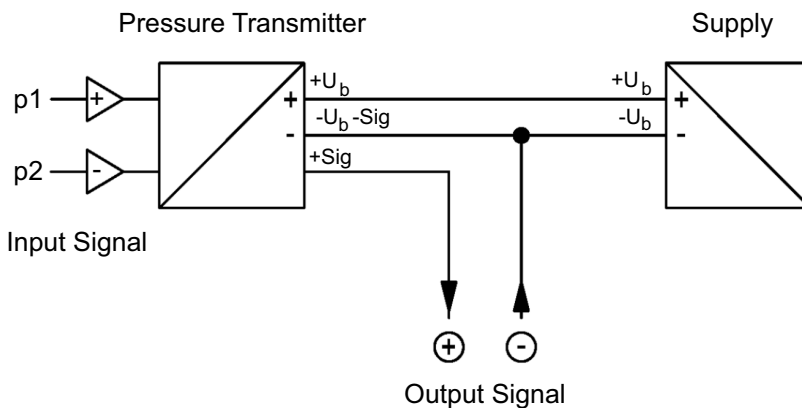

M12 Connector 5-Pin

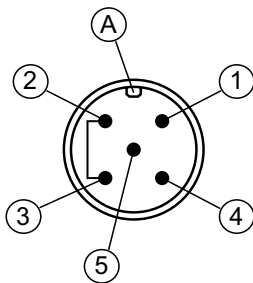

Connector 1: Supply and output signal

Pos.	Description	Cable Color
1	+U _b Versorgung (+)	braun
2	-Sig Offgang (-)	weiss
3	-U _b Versorgung (-)	blau
4	+Sig Offgang (+)	schwarz
5	FE Functionserde	grün/gelb
A	Codierung	

M12 Connector 4-Pin

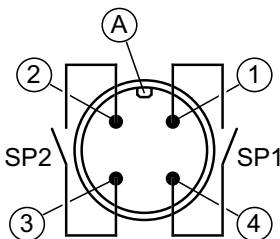

Connector 2: Switch outputs

Pos.	Description	Cable Color
1	SP1 SchaltOffgang 1	braun
2	SP2 SchaltOffgang 2	weiss
3	SP2 SchaltOffgang 2	blau
4	SP1 SchaltOffgang 1	schwarz



5 Start-up

The device must be properly installed before it is started up. Carry out the following before initial start-up:

- Pressure the measuring line
- Test the leak-tightness of all components of the measuring orifice

5.1 Display

The 4-digit LCD display shows the current flow rate (m³/h, L/min etc.) in normal operation. For the display of very large values, it is possible to switch to a 5 or 6 digit display.

Display: Measured value

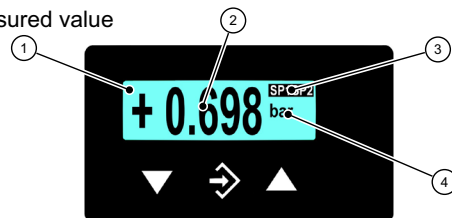

Display: Bar chart

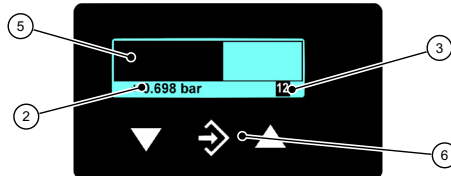

1 LCD with back lighting	2 Measured data display
3 Status display of the switch points	4 Unit
5 Bar chart display	6 Keyboard

The display section is set at the factory according to order specifications. Changes can be made using the following instructions in sections 5.2 and 5.3.

The unit is shown on the right of the display. If the device is equipped with contacts, a closed contact is always symbolised by an inverted text “SP1” or “SP2”.

Various colours can be selected for the back lighting. Depending on the measured value, the colour of the back lighting can automatically be changed. This can be used e.g. to depict good/poor differences. The back lighting can also be deactivated.

The measured value can also be shown in a bar chart. The measured value is also shown in smaller pictures as a number.

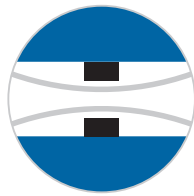

During the programming, the menu items and the associated parameters are shown on the display. The device continues to function whilst the parameters are being set; apart from one exception, the changes come into effect instantly. The exception here is a change of switching times - here the previously valid time must have run down.

5.2 Setup

The instrument has comprehensive setup options by means of which it can be optimized for any specific measuring or control application. This section of the document provides information and instructions about each of the setup parameters.

Depending on the instrument configuration ordered (e. g.: without transmitter signal output/with voltage signal output/with current signal output) some of the menu options may not be available. Some setup parameters may be consequentially excluded. For example, if the instrument is ordered without a transmitter output, all signal conversion programming options are omitted in the setup menu.

All the device settings can be made easily on the PC using the PC adapter. You will need a Transmitter PC Interface and the associated PC software. For more details, please refer to the Accessories section. The PC software makes all parameters directly visible and accessible. Also, the entire configuration can be loaded, saved and documented as a printout.

5.2.1 Keyboard

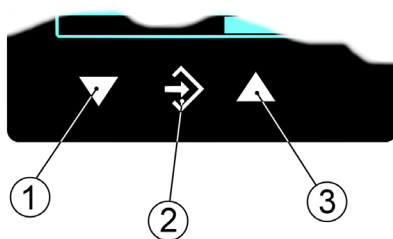

1	Page down menu	Reduce value
2	Call up menu	Save value
3	Page up menu	Increase value

The individual menu items and parameters can be displayed using the buttons **1** and **3**. The respective menu item is selected or the parameters for making changes are called up via the button **2**.

If a parameter can be changed, the display flashes. The change is made via the buttons **1** and **3**. The value is saved with the button **2**.

To leave a menu level or the entire menu, select the parameter „**Menu level Quit**“ and press **2**.



Example: Switch-on point set switchpoint 1

In normal mode, press the button to enter the menu. The **menu level Switch points** appears. Press the enter key again to call up the display parameter. The first parameter **SP 1 On** is displayed. To change this parameter, press the button again.

The device jumps to the input:

- The parameter is stated in the 1st line.
- The value that is to be changed is shown in the 2nd line, the display flashes.
- The input limits are displayed in the 3rd line (if there is one).

The required value is set with the buttons and , then confirmed with .

5.3 Menu levels

The menu levels are structured as follows:

The following tables provide an overview of the parameters of the individual menu levels. In the Menu Level System you can change to the respective national language using the language parameter. You can see which languages are supported there.

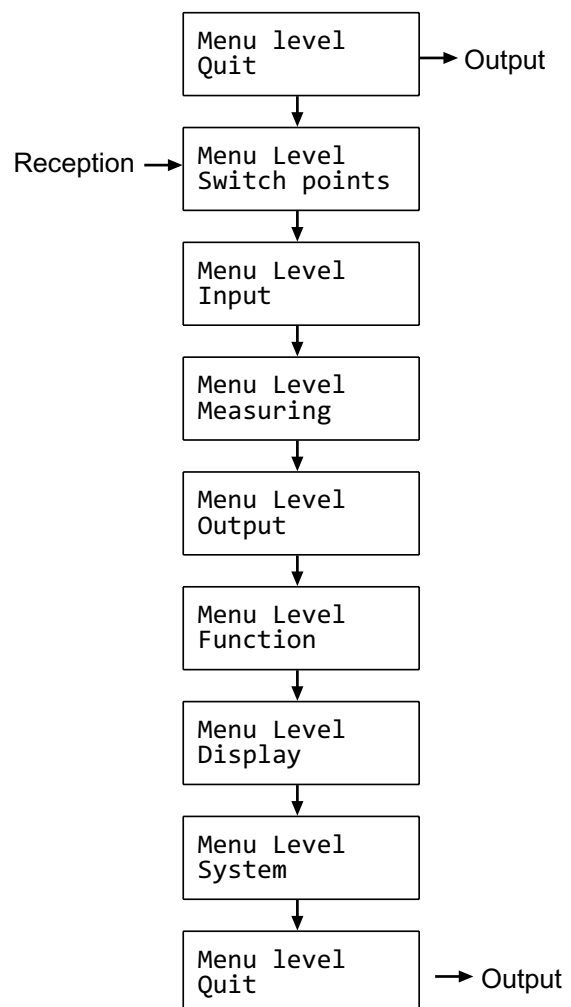

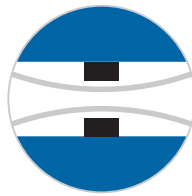

5.3.1 Menu Level Switch points

Parameter name	Description	Value range
SP1 On	Switching point 1 On	MBA-50% ... MBE+50%
SP1 Off	Switching point 1 Off	MBA-50% ... MBE+50%
SP1 Delay	Switching point 1 Delay	0...1800 s
SP1 Function	Switching point 1 Function	NO, NC
SP2 On	Switching point 2 On	MBA-50% ... MBE+50%
SP2 Off	Switching point 2 Off	MBA-50% ... MBE+50%
SP2 Delay	Switching point 2 Delay	0...1800 s
SP2 Function	Switching point 2 Function	NO, NC

The two switch outputs are configured by four parameters respectively.

For the switch point 1 these are:

- **SP1 On**
- **SP1 Off**
- **SP1 Delay**
- **SP1 Function**

Accordingly for switch point 2:

- **SP2 On**
- **SP2 Off**
- **SP2 Delay**
- **SP2 Function**

The function of the individual parameters is explained for both switch points using Switch point 1 as an example.

SP1 On defines the activation point, **SP1 Off** the deactivation point of switch output 1. The values are shown in the valid unit and set accordingly. The values are shown in the valid unit and set accordingly. Both parameters can be set in-dependently over the entire value range.

The value range ranges from MRS -50% to MRE +50%. MRS stands for measuring range start and MRE for measuring range end.



Example: Measurement range = 0 ... 100 Pa

The value range for this measuring range is -50 Pa ... +150 Pa.

Together, the two parameters **SP1 On** and **SP1 Off** determine the switch function of switch output 1:

If **SP1 On** > **SP1 Off**, the output switches on, if the measured value exceeds SP1 On. It is only switched off again if the measured value SP1 Off is undercut (hysteresis function).

- If **SP1 On** = **SP1 Off**, the output switches on if the measured value exceeds SP1 On and off if the measured value undercuts the same value (SP1 Off).
- If **SP1 On** < **SP1 Off**, the output switches on, if the measured value lies within these switch points:
i.e: **SP1 On** < Measured value < **SP1 Off** (window function).

SP1 Delay allows the reaction of the switch output to be delayed by between 0 and 1800 s. This parameter applies equally for switching on and off.

SP1 Function changes the function of the switch output 1. It is possible here to define whether the contact should work as a open contact (NO) or a break con-tact (NC).

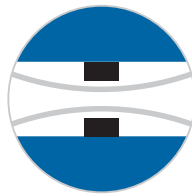

5.3.2 Menu Level Input

Parameter name	Description	Value range
Absorption	Attenuation, damping	0...100 s
Offset corr.	Offset correction	$\frac{1}{3}$ basic measuring range
Zero-pt. wind.	Zero-point window	$\frac{1}{3}$ basic measuring range

If there are unsteady pressure readings during operation, you can use the parameters **Absorption** and **Zero-pt. wind.** to stabilise the reading and the output signal.

The parameter **Absorption** functions like a capillary throttle. However, it only acts on the display, output signal and switch points (if these exist) but not on the measuring cell itself.

You can set the response time to pressure jumps in the range 0.0 to 100 s.

Note: At maximum damping it can take over 2 minutes until the pressure jump from the nominal pressure 100% to 0% is also shown as zero in the display.

In many cases, unsteady readings are not a problem during normal operating mode, but this is not true for the idle state, i.e. if a measured value of zero is expected. The parameter **Zero-pt. wind.** is designed to solve this. Its value defines a range around zero at which the measured value is set to zero (see fig.).

The display only stops showing zero when the pressure leaves the set window. When twice the window value is reached, the measuring pressure and the display correspond again. This avoids jumps in the display.

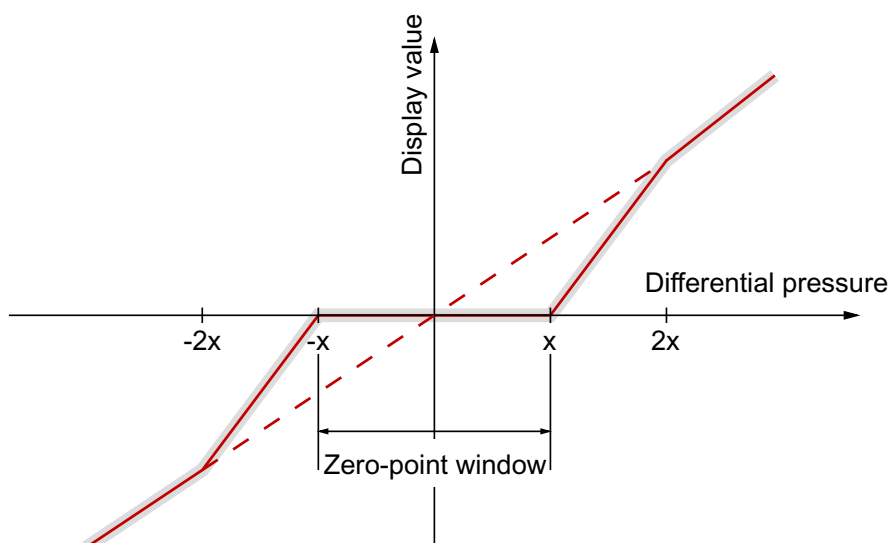



It makes sense to set the Offset (zero-point displacement) if, without differential pressure (remove measuring line), the display shows a value that is not zero. Before the offset correction, the zero-point window must be set to zero.

Select the **Offset corr.** parameter and correct the reading using the buttons or until zero is shown in the display.

When setting the offset, the current measured value is displayed. The zeropoint window is not active during the offset setting.

5.3.3 Menu Level Measuring

Parameter name	Description	Value range
MB start	Measuring range start	Basic measuring range
MB end	Measuring range end	Basic measuring range
Unit	Measuring range unit	bar, mbar, Pa, kPa, MPa, psi, InWc, mmWs, mmHg
Limit	Measuring range limit	yes, not

The transmitter output signal primarily depends on the sensed pressure. However, you have the option of adjusting the output signal to a large extent to suit your requirements.

Note: Adjustment of the output signal

The basic measuring range (indicated on the type label) and the type of output signal (voltage / current) are not variable.

The parameters **MB start** and **MB end** initially define the two pressures between which the output signal will change at all. Both values are adjustable across the entire basic measuring range. The set values also refer to the pressure in the respective unit. However, the signal values (current / voltage) for 'Start of measuring range' and 'End of measuring range' are fixed.

If **MB start** is smaller than **MB end**, this is called an increasing characteristic curve; the output signal increases as the pressure increases. If **MB end** is smaller than **MB start**, this is a decreasing characteristic curve and the output signal decreases as the pressure increases.

The difference between the values **MB start** and **MB end** must be at least 25 % of the basic measuring range. You can select a unit other than the unit of the basic measuring range with the parameter **Unit**. The user should remember however that not every unit is suitable. The conversion is automatic.

The parameter **Limit** allows the display, output and switching points to be limited to the range between Start of measuring range and End of measuring

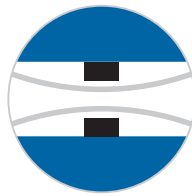

range. This makes sense when content is measured to avoid „negative contents“. If Limit is set to „no“, those measured values that are greater or smaller than the end values are shown.

5.3.4 Menu Level Output

Parameter name	Description	Value range
<i>min. output</i>	min. output	0,0 ... 21,0 mA or 0,0 ... 11,0 V
<i>max. output</i>	max. output	
<i>Error signal</i>	Measuring range unit	

The parameters ***min. output***, ***max. output*** and ***error signal*** define the limits of the output signal that may not be undercut or exceeded regardless of the pressure. The limit values take priority over the range defined by the ***MB start*** and ***MB end*** parameters! These parameters primarily serve to prevent error messages in downstream systems caused by brief overstepping of measuring ranges.

The parameter ***min. output*** is usually only used for devices with an output signal 4...20 mA because frequently values of below 3.8 mA are evaluated as error signals.

The ***max. output*** value can be used for the voltage and current to limit the maximum value.

The value defined via the parameter ***Error signal*** is issued if the device detects an internal error and can no longer work correctly. It should be noted here that not all potential errors and faults can be detected by the device itself.



5.3.5 Menu Level Function

The Function menu level is a variable menu whose appearance depends on the value of the Function parameter. There are linear, square rooted and table functions

Linear function

The input signal is linear before being sent to the display and the output. The range defined in the menu „Measuring“ serves as the measuring range. If the function LINEAR is active, the other menu items are cancelled.

Parameter name	Description	Value range
Function	Function	Value = linear

Square rooted function

Here, the input signal is square rooted before being sent to the display and the output. This is necessary e.g. for flow measurements with differential pressure. A free unit can be defined for the display. To do this, the start and end of the display range and the number of decimal points are defined. It is also possible to define the unit with 4 characters.

Parameter name	Description	Value range
Function	Function	Value = square root
MB decimal pl.	Measuring range decimal places	1234, 123.4, 12.34, 1,234, 12345, 123456
MB start	Measuring range start	-9999 ... +9999
MB end	Measuring range end	-9999 ... +9999
MB unit	Measuring range unit	4 characters

The following section contains descriptions of the parameters MB decimal pl., MB start, MB end and MB unit to describe the table function.

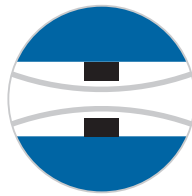

Tables function

This function allows free adjustment of the input variable to the display and output via a table with up to 30 support points. A value pair comprising a measured value and display value is issued for every support point.

Hinweis: Change of parameter

When switching from TABLE to another function, the table is initialised again and the existing values are lost.

Parameter name	Description	Value range
Function	Function	Value = square root
MB decimal pl.	Measuring range decimal places	1234, 123.4, 12.34, 1,234, 12345, 123456
MB start	Measuring range start	-9999 ... +9999
MB end	Measuring range end	-9999 ... +9999
MB unit	Measuring range unit	4 characters
Value pair1	Value pair1	MB-start ... MG-end
Value pair2	Value pair2	
Value pair3	Value pair3	
	...	
Value pair30	Value pair30	

The display range is defined with the parameters **MB decimal pl.**, **MB start** and **MB end**. The user can select the configuration freely.

Using the parameter **MB decimal pl.**, it is possible to select between a 5 or 6- digit presentation. The resolution is not increased. Only an extra zero or two zeros are added. This serves the correct display of larger values. The measuring range must be positive for the 6 digit presentation.

The **MB unit** gives the user the option of defining a completely independent unit. Letters, numbers or special characters can be used. The unit can be max. 4 characters long.

If the function TABLE is selected, then it is also necessary to state the **No. of pairs**. It is defined here how many pairs of values (support points) are used in the table. A table is made up of at least 3, max. 30 support points.

Note: Number of value pairs

If the number of value pairs is changed, the table is initialised again and the existing values are deleted.



Example:

1	Value pair	2
	+14,6 mbar	+8,6 %
	+0,0 ... +100,0 mbar	

- 1 input mark (value flashes)
- 2 allowed range of values

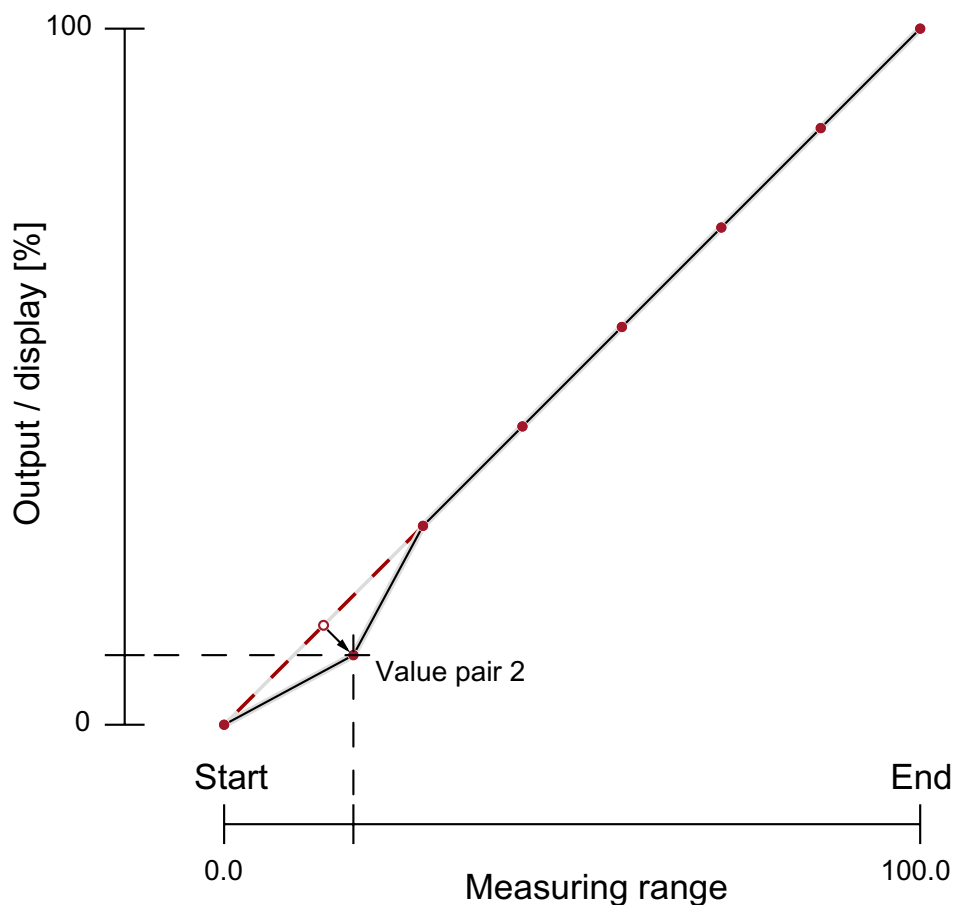

The individual value pairs can be seen and changed with the Value **pair1** to Value **pair30** parameters. A value pair comprises a measured value (left side) and a display value (right side). The measured value must lie within the measuring range and the display value must lie within the defined „free unit“. The respective limits are shown during input. The table must contain either increasing or decreasing values. The table must contain either continuously increasing or continuously falling values. A change from an increasing to a decreasing characteristic curve within a support point table is not allowed.

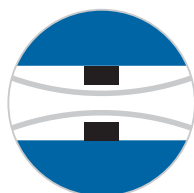

5.3.6 Menu Level Display

The Display menu level is a variable menu whose appearance depends on the value of the colour parameter. In addition to the various colours for the background lighting, there are also two auto-functions with colour switching available.

Parameter name	Description	Value range
Colour	Colour	Off, red, green, yellow, blue, pink, turquoise, white, Auto1: Red-green Auto2: Red-yellow-green
Lighting	Lighting time	0 s, 10 ... 600 s
Contrast	Contrast	15 ... 45
Bar chart	Barchart display	yes, no

The most important parameter is **Colour**. A fixed colour can be defined for the background colour here. There are also two auto-functions with colour switching available. Alternatively, the background illumination can be permanently deactivated.

If permanent lighting is not required, the parameter **Lighting time** can be used to define when the lighting should be switched off after the last time a button is pressed. In addition to permanent lighting (0 s), automatic shut-down after 10...600 s is also possible. The set time is only valid if the parameter **Colour** is not set to „off“.

Amongst other things, the legibility of the display depends on the temperature and the reading angle. To ensure optimised legibility, the display can be adjusted using the parameter **Contrast**. When the contrast is changed, it is possible that the display appears empty or almost completely black. In this case, the contrast must be turned up or down.

Via the parameter **Bar chart**, the display can be switched between a display where the measured value is either shown in large digits or the display shows small digits and an additional barchart.



Auto1: Colour-change red to green

In the mode with the automatic colour switchover, it is possible to enter the re-quired switch thresholds „red-green switchover“, „green-red switchover“.

The switching thresholds can be moved within the measuring range. The seriesof switch points cannot be altered.

Parameter name	Description	Value range
Red-Gr. switch.	Red-green switching	MRS - 50% ... MRE + 50%
Gr-Red switch.	Green-red switching	
Hysteresis	Hysteresis	0.1 ... 10.0 %
Delay	Delay	0 ... 1800 s
Colour	Colour	Off, red, green, yellow, blue, pink, turquoise, white, Auto1: Red-green Auto2: Red-yellow-green
Lighting	Lighting time	0 s, 10 ... 600 s
Contrast	Contrast	15 ... 45
Bar chart	Barchart display	yes, no

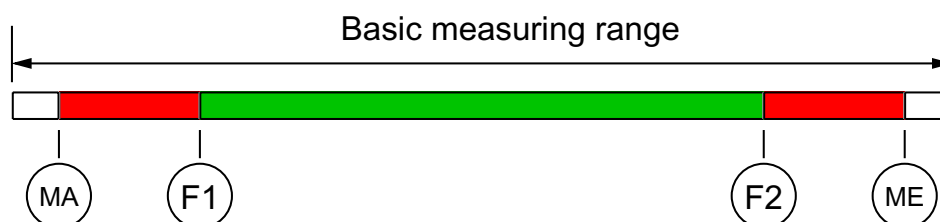

MA	MB-start	Measuring range start
F1	Red-Gr. switch.	Red-green switching
F2	Gr-Red switch.	Green-red switching
ME	MB-end	Measuring range end

The parameter **Hysteresis** can be used to prevent fast and unwanted colour changes. The hysteresis is set in the range 0.1... 10%.

Note: Overlapping colour areas

In the case of large hysteresis values, steps must be taken to ensure that the ranges of the individual colours do not overlap. Otherwise it is possible that the colour change may not function in the desired way.

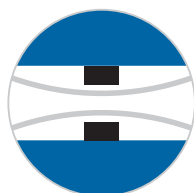

The parameter **Delay** offers a further option to prevent unwanted colour changes. The colour change here can be delayed between 0...1800 s.

The parameter **Lighting** can be used to define when the lighting should be switched off after the last time a button is pressed. In addition to permanent lighting, automatic shut-down after 10...600 s is also possible. The set time is only valid if the parameter **Colour** is not set to „off“. The lighting can be switched on permanently with the value 0s.

The legibility of the display can be adjusted using the parameter **Contrast**. When the contrast is changed, it is possible that the display appears empty or almost completely black. In this case, the contrast must be turned up or down again.

Via the parameter **Bar chart**, the display can be switched between a display where the measured value is either shown in large digits or the display shows small digits and an additional barchart.

Auto2: Colour-change red-yellow-green

In the Auto 2 mode with the automatic colour switchover, it is possible to enter the required switch thresholds “red-yellow switchover”, “yellow-green switchover”, green-yellow switchover, “yellow-red switchover”.

The switching thresholds can be moved within the measuring range. The series of switch points cannot be altered.

Parameter name	Description	Value range
Red-Yell.switch.	Red-yellow switchover	MRS - 50% ... MRE + 50%
Yell.-Gr.switch.	Yellow-green switchover	
Gr.-Yell. switch	Green-yellow switchover	
Yell.-Red switch	Yellow-Red switchover	
Hysteresis	Hysteresis	0.1 ... 10.0 %
Delay	Delay	0 ... 1800 s
Colour	Colour	Off, red, green, yellow, blue, pink, turquoise, white, Auto1: Red-green Auto2: Red-yellow-green
Lighting	Lighting time	0 s, 10 ... 600 s
Contrast	Contrast	15 ... 45
Bar chart	Barchart display	yes, no

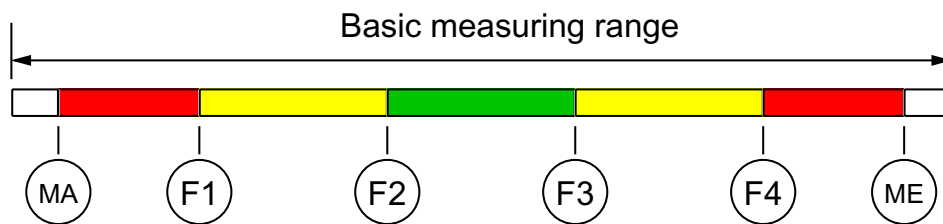

MA	MB-start	Measuring range start
F1	Red-Yell.switch.	Colour-change red to yellow
F2	Yell.-Gr.switch.	Colour-change yellow to green
F3	Gr.-Yell. switch	Colour-change green to yellow
F4	Yell.-Red switch	Colour-change yellow to red
ME	MB-end	Measuring range end

In this menu the same parameters are used as those described in the previous sections.

Note: Unused range

If a range is not to be used, the associated switch thresholds (F1...F4) can be set to the same value.

Example:

The parameter Colour is set to Auto2. Only the green, yellow and red ranges are required here. To fade out the lower ranges red and yellow, the switch thresholds „red-yellow switching“ and „yellow-green switching“ are set to the start of the measuring range.

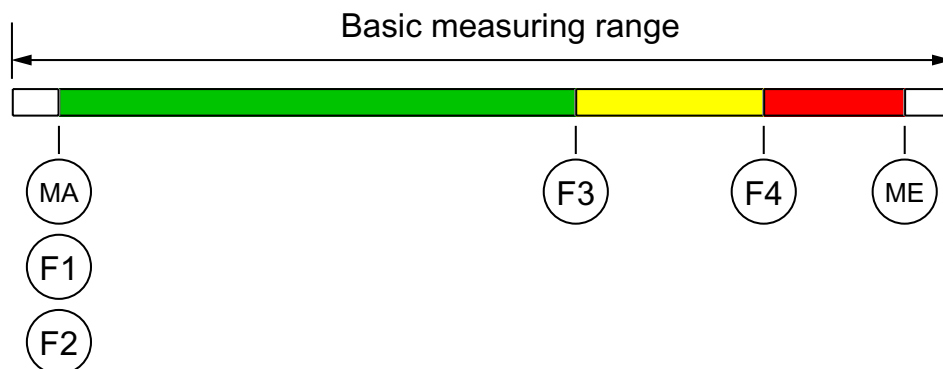

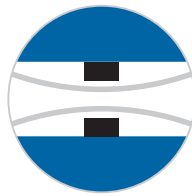

5.3.7 Menu Level System

Parameter name	Description	Value range
Language	Language change	DE, EN, FR, ES, IT,PT,HU
Software Info	Information about the software	Device type, serial number, firmware version
Config. Info	Information about the configuration	Basic measuring range, output signal, contacts
Statistics	Statistics	Operating time, switch cycles of the contacts
Password	Password	0/1...999
Load config.	Load configuration	
Save config.	Save configuration	

The user menu can be switched to German, English, French, Spanish, Italian, Portuguese or Hungarian using the parameter **Language**.

The menu items **Software Info** and **Config. Info** provide information about the device. This information helps to answer questions about the device quickly.

- The serial number and the firmware version is shown in **Software info**. If a ‚designation‘ has been assigned, this is also issued. Please note that a ‚designation‘ can only be entered with the PC software by remote configuration.
- The basic measuring range, the defined output signal and existing contacts are stated in the **Config. Info**.

The **Statistics** provide information about the operating time and the relay switching cycles from the time of delivery. The operating time is shown in days (d) and hours (h).

A **Password** can be used to protect the menu against unauthorised access. The password is a figure from 1 to 999. The input 0 means that no password is active.

The password needs to be set if the user presses the button in normal mode to enter the menu. If a wrong password is entered, the system automatically jumps back to normal mode again. If no password is active, the display immediately jumps to the menu.

Note: Forgotten password

The user cannot restore a forgotten password. Please contact the manufacturer in this case.



The user can load a saved configuration via the menu item **Load config**. This means that a functional set of parameters can be loaded after trying out various settings.

The menu item **Save config** serves to save the existing parameters in a protected memory area. This is helpful if the settings of a functional device needs to be optimised. **Save config** and **Load config** can be used to quickly restore the initial status again.

Note: Delivery condition

If the user has not yet saved a configuration, the default values (status on delivery) are loaded. In this case, any measuring range spreads or switch points are reset and the device needs to be newly configured.

6 Service

All devices with defects or deficiencies should be sent directly to our repair department. In the service area of the Kirchner und Tochter homepage (www.kt-flow.de) you will find the declaration of decontamination as download and more information about returns.

To avoid risks to our employees and the environment, we can only process devices, for which we get a declaration of decontamination certifying that they are safe due to legal regulations. For questions, please contact our sales department, Tel. +49 2065-96090.

7 Disposal

Please help to protect our environment and dispose workpieces in conformity with current regulations resp. continue using them.

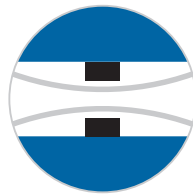

8 Technical data

Measuring principle	differential pressure measurement on the orifice DDM-EM
Perm. ambient temperature	-10 ... + 70 °C
Perm. medium temperature ¹⁾	standard -10 ... + 70 °C, max. 130 °C (insulated line) optionally HT-Type above 130 °C
Pressure loss	ca. 30 ... 60 % of differential pressure ²⁾
Pressure resistance	16 bar
Protection class	IP 65 acc. to DIN EN 60529
Measurement accuracy	5 % of measurement range end value
Display unit	electronic differential pressure transmitter with 3½ digit LED display and 4 ... 20 mA, 0 ... 10 V output
In-between flange (DN)	for PN 10/PN 16 flanges acc. to DIN EN 1092-1 shape A & B
Pipe union (Rp)	two-part pipe fitting: insert with cylindrical internal thread acc. to DIN EN 10226-1 (ISO 7-1)
External thread (Ga)	cyl. external thread acc. to DIN EN ISO 228
Internal thread (Gi)	cyl. internal thread acc. to DIN EN ISO 228

¹⁾ medium must not freeze

²⁾ is detailed in the offer

8.1 Technical data display unit EM

Nominal voltage	24 V DC/AC
Perm. operating voltage	12 ... 32 V DC/AC
Output signal	0 ... 20 mA, 4 ... 20 mA, 0 ... 10 V three-wire
Protection class	IP 65 acc. EN 60529
Signal load	
Current output 0/4 ... 20 mA	$U_b \leq 26 \text{ V: } R_L \leq (U_b - 4 \text{ V}) / 0,02 \text{ A}$, $U_b > 26 \text{ V: } R_L \leq 1100 \Omega$
Voltage output 0 ... 10 V	$U_b < 15 \text{ V: } R_L \geq 10 \text{ k}\Omega$, $U_b \geq 15 \text{ V: } R_L \geq 2 \text{ k}\Omega$
Power consumption	ca. 2 W/WA
Programmable switching contacts	
2 sets of voltage free relay contacts as make (no) or break (nc) contact	$U_{\max} = 32 \text{ V DC/AC}$, $I_{\max} = 2 \text{ A}$, $P_{\max} = 64 \text{ W/WA}$
2 sets of voltage free solid state relay SPST as make (no) or break (nc) contact	$U = 3 \dots 32 \text{ V DC/AC}$, $I_{\max} = 0,25 \text{ A}$, $P_{\max} = 8 \text{ W/WA}$
Display	4stellige LED



8.1.1 Programming display unit EM

Damping	0 ... 100 s (10 / 90% step response time) for signal output, display separated
Switch output	Switch-off point, switch-on point, response time (0...1800s), function (NC / NO contact)
Measuring range unit	bar, kPa, „free unit“ start value, end value and decimal place for „free unit“
Output signal	User-definable within the basic measuring range ⁽¹⁾
Zero point stabilising	0... 1/3 of the basic measuring range ⁽²⁾
Zero point correction	± 1/3 of the basic measuring range ⁽³⁾
Curve conversion	linear, square rooted, table with 3...30 support points
Password	001 ... 999 (000 = no password protection)
Language (can be switched)	DE, EN, FR, ES, IT, PT, and HU

Notes:

- ¹⁾ Max. effective spread 4:1
- ²⁾ measured values around zero are set to zero.
- ³⁾ To compensate different installation positions.n

8.1.2 Connections

Electrical connections	Two round-shell multi-pin connector sockets (M12, male) Connector 1: 5-pin: power input and analog signal output Connector 2: 4-pin: relay contacts / solid-state switch outputs
Pressure connections	G 1/8 female threads with optional cutting ring fittings for 6 or 8 mm tube

8.2 Type series

DDM-EM DN	measuring orifice sandwiched between flanges
DDM-EM Rp	measuring orifice with pipe fitting
DDM-EM Gi	measuring orifice with internal threads
DDM-EM Ga	measuring orifice with external threads

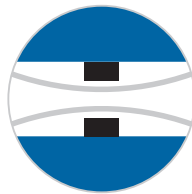

8.3 Technical data of orifice

8.3.1 Connection

DDM-DN	between flanges PN10 or PN16 acc. to DIN EN 1092-1
DDM-Rp	two-part pipe fitting: insert with cylindrical internal thread acc. to DIN EN 10226-1 (ISO 7-1)
DDM-Ga	Cylindrical male thread according to DIN ISO 228 T1.
DDM-Gi	Cylindrical female thread according to DIN ISO 228.

8.3.2 Materials

DDM-EM DN	
Ring	S355, optionally 1.4571
Corrosion protection	Epoxy powder coating, traffic blue (RAL 5017) glossy
Corrosion class	C3
Orifice	1.4571
DDM-EM Rp, Gi, Ga	
Pipe union (Rp)	malleable cast iron, zinc plated
Orifice and ring	brass, optionally 1.4571
Gaskets	NBR
Connection between orifice and indicator	
Straight screw-in fitting 1/4"	brass, nickel plated, 1.4571 on request
Screw fitting G 1/4" dia. Ø 8	brass, nickel plated, 1.4571 on request
Cutting ring, union nuts	steel, zinc plated, 1.4571 on request
Steel sealing	steel, zinc plated, with NBR seal
Indicator EM	
Parts in contact with media	Brass, NBR, FKM
Measuring diaphragm	NBR
Housing	polyamide PA 6.6

other materials on request



8.4 Dimensions

8.4.1 Dimensions for DDM-EM DN

DN *)	d4	H
50	102	282
65	122	302
80	138	318
100	158	338
125	188	368
150	212	392
200	268	448

*) Inside diameter made after details provided of pipe inside diameter.

8.4.2 Dimensions for DDM-EM Rp

Rp *)	L1	L2	SW	H
¼	80	124	41	200
⅜	80	128	46	203
½	80	128	46	203
¾	80	128	50	205
1	80	136	60	210
1¼	80	146	70	215
1½	80	149	70	215
2	90	164	85	222

*) Inside diameter made after details provided of pipe inside diameter.

8.4.3 Dimensions for DDM-EM Gi/Ga

Gi *)	Ga *)	L	SW	H
¼	⅝	80	41	200
⅜	¾	80	46	203
½	1 ⅛	80	46	203
¾	1 ¼	80	50	205
1	1 ½	80	60	210
1¼	2	80	70	215
1½	2 ¼	80	70	215
2	2 ¾	90	85	222

*) Oinside diameter made after details provided of pipe inside diameter.

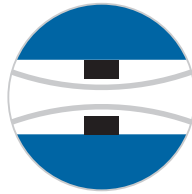

DDM-EM

Differential pressure flow meters

DDM-EM DN

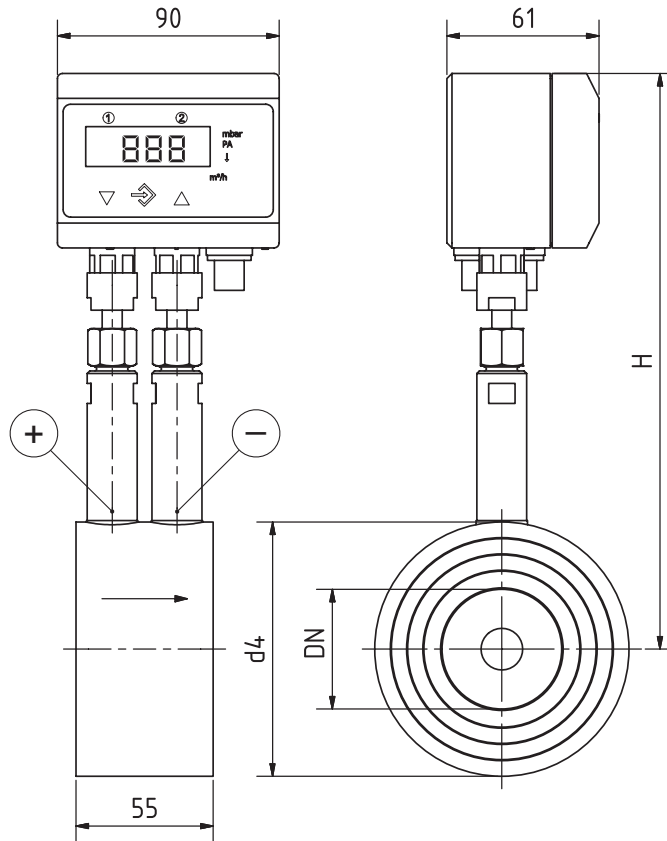

DDM-EM Gi

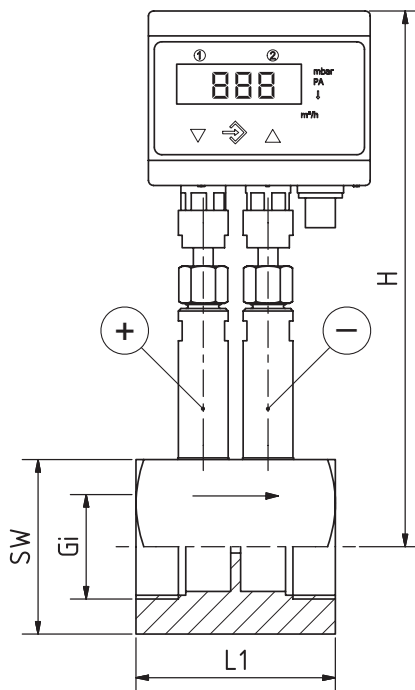

DDM-EM Ga/Rp

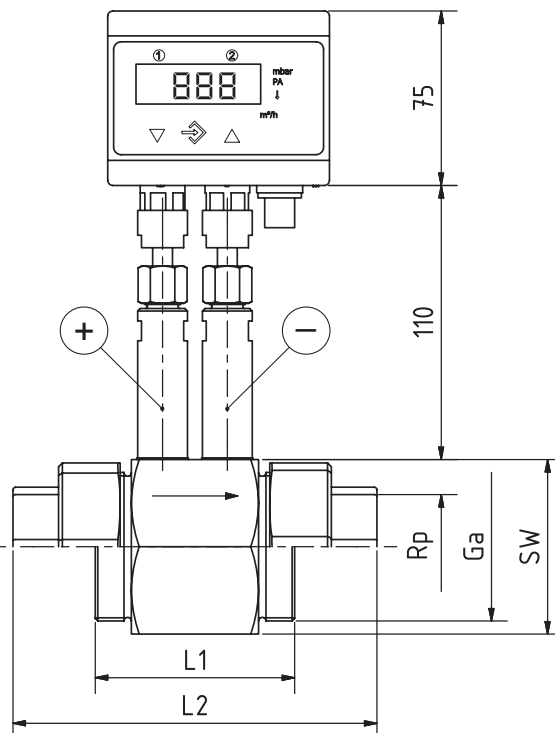



8.5 Measuring ranges

8.5.1 Water

Connection: screwed pipe union/internal thread/for external thread

Rp Gi	Ga	smallest measuring range [m ³ /h] H ₂ O			largest measuring range [m ³ /h] H ₂ O		
1/4	5/8	0,075	-	0,3	0,3	-	1,2
3/8	3/4	0,1	-	0,4	0,575	-	2,3
1/2	1 1/8	0,175	-	0,7	1,125	-	4,5
3/4	1 1/4	0,325	-	1,3	2,125	-	8,5
1	1 1/2	0,5	-	2	3,375	-	13,5
1 1/4	2	0,875	-	3,5	6	-	24
1 1/2	2 1/4	1,25	-	5	8	-	32
2	2 3/4	1,875	-	7,5	13	-	52

in-between ranges possible

Connection for in-between flange assembly

DN	smallest measuring range [m ³ /h] H ₂ O			largest measuring range [m ³ /h] H ₂ O		
50	1,75	-	7	13	-	52
65	3	-	12	19,5	-	78
80	4,5	-	18	29,5	-	118
100	7	-	28	46	-	184
125	11	-	44	72	-	288
150	16	-	64	103,25	-	413
200	28,25	-	113	183,75	-	735

in-between ranges possible

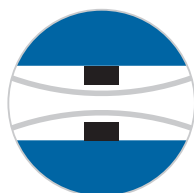

8.5.2 Air

Connection: screwed pipe union/internal thread/for external thread

Rp Gi	Ga	smallest measuring range [m ³ /h] air ¹⁾			largest measuring range [m ³ /h] air ¹⁾		
1/4	5/8	0,75	-	3	2	-	8
3/8	3/4	1,25	-	5	3,5	-	14
1/2	1 1/8	1,5	-	6	5,25	-	21
3/4	1 1/4	2	-	8	11,25	-	45
1	1 1/2	3	-	12	13,5	-	54
1 1/4	2	6	-	24	27	-	108
1 1/2	2 1/4	8,75	-	35	37,5	-	150
2	2 3/4	12,5	-	50	67,5	-	270

¹⁾at STP (0 °C and 1013 mbar), in-between ranges possible

Connection for in-between flange assembly

DN	smallest measuring range [m ³ /h] air ¹⁾			largest measuring range [m ³ /h] air ¹⁾		
50	13,5	-	54	67,5	-	270
65	20,25	-	81	125	-	500
80	30	-	120	187,5	-	750
100	52,5	-	210	212,5	-	1080
125	90	-	360	437,5	-	1750
150	112,5	-	450	650	-	2600
200	187,5	-	750	1000	-	4000

¹⁾at STP (0 °C and 1013 mbar), in-between ranges possible



Notizen

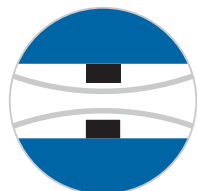

DDM

Differential pressure flow meters

Notizen



Kirchner und Tochter
Durchflussmesstechnik seit 1951

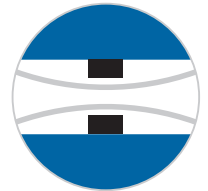

The devices from **Kirchner und Tochter** have been tested in compliance with applicable EC/EU CE-regulations of the European Community.

The respective declaration of conformity is available on request. Subject to change without notice. The current valid version of our documents can be found at www.kt-flow.de.

The **Kirchner und Tochter** QM-System is certified in accordance with DIN EN ISO 9001:2015. The quality is systematically adapted to the continuously increasing demands.