



Supplementary Installation and Operating Instructions

Variable Area Flow Meters

RA 60 Ex / FA 60 Ex

RA 65 Ex / FA 65 Ex

RA 87 Ex / FA 87 Ex



Category:

II 2G Ex IIC

II 3G Ex IIC



Contents

1	General safety directions.....	3
2	Main safety features	4
2.1	Category/zone.....	4
2.2	Ignition protection types	4
2.3	Temperature classes	5
2.4	Operating pressure	6
2.5	Static electricity	6
2.6	Static discharge.....	6
3	Identification	7
4	Installation and setup.....	8
4.1	Electrical connection	8
4.2	Pin assignments.....	9
4.3	Connection cable	9
4.4	Ground connector	10
5	Start-up.....	11
6	Service.....	11
7	Dismantling	12
7.1	Electrical connection	12
7.2	Process connections	12
8	Maintenance	12
9	Annex	13
9.1	TÜV statement [Technical Control Board].....	13
9.2	Declaration of conformity	16



RA 60 Ex / FA 60 Ex
RA 65 Ex / FA 65 Ex
RA 87 Ex / FA 87 Ex

Variable area flow meters

1 General safety directions

This supplement to the installation and operating instructions is valid for explosion protection designs of variable area flow meters of the following series:

- RA 60 Ex/FA 60 Ex
- RA 60-MSK1 Ex/FA 60-MSK1 Ex
- RA 60-MSK12 Ex/FA 60-MSK12 Ex
- RA 60-MSKW Ex/FA 60-MSKW Ex
- RA 65 Ex/FA 65 Ex
- RA 65-MSK1 Ex/FA 65-MSK1 Ex
- RA 65-MSK12 Ex/FA 65-MSK12 Ex
- RA 65-MSKW Ex/FA 65-MSKW Ex
- RA 87 Ex/FA 87 Ex
- RA 87-MSK1 Ex/FA 87-MSK1 Ex
- RA 87-MSK12 Ex/FA 87-MSK12 Ex
- RA 87-MSKW Ex/FA 87-MSKW Ex

It supplements the installation and operating instructions for the designs not for protection from explosions.

The information in these instructions only contains data that are related to explosion protection.

The technical information of the installation and operating instructions for the designs not for protection against explosions remain valid unchanged, as long as they are not excluded or replaced by these instructions.

The variable area flow meters of the series

- RA 60 Ex/FA 60 Ex,
- RA 65 Ex/FA 65 Ex,
- RA 87 Ex/FA 87 Ex

have been tested by TÜV Rheinland according to the European Directive 2014/34/EU per EN 1127-1:2007 and EN 13463-1:2007 for use in potentially explosive areas using the TÜV test report **296/Ex653.00/08**

Danger!



Danger of explosion can result from incorrect handling. Installation, set up, commissioning and service of explosion protected operating material must only be performed by personnel trained in explosion protection („competent person“).



2 Main safety features

2.1 Category/zone

Variable area flow meters of type:

- RA 60 Ex/FA 60 Ex
- RA 65 Ex/FA 65 Ex
- RA 87 Ex/FA 87 Ex

are designed for use in Category 2 according to directive 2014/34/EU and suitable as per EN 60079/14 for use in Zone 1 and Zone 2.
(Also refer to section 9.1 to 9.4)

2.2 Ignition protection types

The electrical circuits of the limit indicator (reed contacts) are designed in the ignition protection type „intrinsically safe“ of category „ia“. They may only be operated with approved and suitable switch amplifiers, whereby the connection values are limited according to Namur. (See section 4.1)

Variable area flow meters of type:

- RA 60 Ex/FA 60 Ex
- RA 65 Ex/FA 65 Ex
- RA 87 Ex/FA 87 Ex

do not fall under 2014/34/EU. (Also see section 9.1)



2.3 Temperature classes

Variable area flow meters of type:

- RA 60 Ex/FA 60 Ex
- RA 65 Ex/FA 65 Ex
- RA 87 Ex/FA 87 Ex

are allowed only in specifically described temperature classes (see Table 1).

The ambient temperature T_{amb} , medium temperature T_m and the material of the variable area flow meter are listed in the table.

Table 1:

Maximum permissible ambient/medium temperatures in °C when used in temperature class T6-T1.

Material of floats and collectors			
Aluminium/ 1.4571 / Hastelloy	PVDF/PTFE	PVC	PP
Temperature class			
T6	T6	T6-1	T6
$T_{amb} : < 40\text{ °C}$	$T_{amb} : < 40\text{ °C}$	$T_{amb} : > 0\text{ °C} < 40\text{ °C}$	$T_{amb} : > 0\text{ °C} < 40\text{ °C}$
$T_m : < 70\text{ °C}$	$T_m : < 70\text{ °C}$	$T_m : < 40\text{ °C}$	$T_m : < 70\text{ °C}$
T5	T5		T5-T1
$T_{amb} : < 40\text{ °C}$	$T_{amb} : < 40\text{ °C}$		$T_{amb} : > 0\text{ °C} < 40\text{ °C}$
$T_m : < 85\text{ °C}$	$T_m : < 85\text{ °C}$		$T_m : < 85\text{ °C}$
T4-T1	T4-T1		
$T_{amb} : < 40\text{ °C}$	$T_{amb} : < 40\text{ °C}$		
$T_m : < 100\text{ °C}$	$T_m : < 100\text{ °C}$		

The table take into consideration the following parameters for determining the permissible temperature class.

- Ambient temperature T_{amb}
- Medium temperature T_m
- Material of the float



2.4 Operating pressure

Glass size	max. operating pressure in bar (p _{max})
9,5; 10; 19; 30	10
36; 43	8
100 (RA/FA60 only)	6
110 (RA/FA60 only)	5
150 (FA60 only)	4
180 (FA60 only)	3

2.5 Static electricity

With variable area flow meters it is basically possible for the electrostatic field, which is generated in the interior of the measuring tube, to reach to the exterior of the device.

Variable area flow meters of type:

- RA 60 Ex/FA 60 Ex
- RA 65 Ex/FA 65 Ex
- RA 87 Ex/FA 87 Ex

are therefore to be permanently grounded (see section 4).

Danger!



Danger of explosion can result from incorrect connection. The operating company is responsible for installing error free grounding of the process line.

2.6 Static discharge

Surfaces can be electrostatically combustibly charged during cleaning (e.g. Plexiglas protection on viewing window). These surfaces are marked with the shown adhesive label.



Caution! Measures against static charging

Do not rub the plastic surface.
Clean surfaces only with damp cloth.

The marked locations may be cleaned only with a damp, lint-free cloth. In addition, caution should be taken not to rub against these surfaces with clothing, since static charge can occur at any time. Dust deposits on the housing of the variable area flow meter are also to be removed with a damp cloth. The deposits must not exceed a thickness of 3 mm.





RA 60 Ex / FA 60 Ex
 RA 65 Ex / FA 65 Ex
 RA 87 Ex / FA 87 Ex

Variable area flow meters



3 Identification

The identification of the entire device is done on the sleeve parallel to the viewing window with the following rating plates:



RA/FA 60:

 Kirchner und Tochter D-47228 Duisburg www.kt-web.de	RA 60-MSK1 Ex		
	Jahr	08	SN 77777-007-08 Pmax 10
	Tag-NoTAG5		
	  0085 PED0085 BN0045		

RA/FA 65:

 Kirchner und Tochter D-47228 Duisburg www.kt-web.de	RA 65-MSK1 Ex		
	Jahr	08	SN 77777-009-08 Pmax 10
	Tag-NoTAG5		
	  0085 PED0085 BN0045		

RA/FA 87:

 Kirchner und Tochter D-47228 Duisburg www.kt-web.de	RA 87-MSK1 Ex		
	Jahr	08	SN 77777-010-08 Pmax 10
	Tag-NoTAG5		
	  0085 PED0085 BN0045		

CE	CE mark subscript: notified body ref. to pressure equipment directive 2016/68/EU
Year	Year of manufacture
Pmax	Max. allowable operating pressure
Tag No.	Measurement point marking
SN	Serial number

Composition of the serial number nnnnn-mmm-yy

Example:

77777-010-08	Order number 77777 Device no. 10 in order with year of manufacture 2008
--------------	-------------------------------------------------------------------------------



4 Installation and setup

Danger!



Danger of explosion can result from incorrect handling. Installation, set up, commissioning and service of explosion protected operating material must only be performed by personnel trained in explosion protection („competent person“).

The instructions of the installation and operating instructions and the supplement to the installation and operating instructions are absolutely to be followed here.

Calibration of the variable area flow meters with respect to the area of use is to be checked by inspection of the rating plate.

The variable area flow meter is to be grounded.

(Also refer to the illustration in section 4.4 for this)

If the equipment is not sufficiently grounded via the process line, an additional ground connection is to be created via the ground connection on the back of the sleeve. The connection only guarantees an electrostatic connection of the equipment and does not meet the requirements of a potential equalization connection.

The equipment must be operated with an upstream throttle valve if possible pressure surges in the piping cannot be operationally avoided.

4.1 Electrical connection

The simple, intrinsically safe reed contact is fastened to the variable area flow meter.



This reed contact must only be done by a type-approved, suitable switch amplifier with intrinsically safe electrical circuits. The following maximum values must be observed:

Characteristic data		
Installed reed contact	U _i	I _i
MSK1 Ex	20 V DC	40 mA
MSK12 Ex		
MSKW Ex		

These reed contacts do not assume safety relevant functions within the system.



RA 60 Ex / FA 60 Ex
RA 65 Ex / FA 65 Ex
RA 87 Ex / FA 87 Ex

Variable area flow meters

4.2 Pin assignments

The electrical connection of the installed reed contact is described in the installation and operating instructions and pictured on the contact plug.

For the „Ex“ design, the remark „500 V proofed“ must be on the contact label as shown in the following illustration. In addition, the type designation also contains „Ex“. Only equipment with this tested and marked contact is allowed for operation in the „Ex area“. The operating company of the system must ensure that the contact label shown below is present on the reed contact.

„Ex“-marking

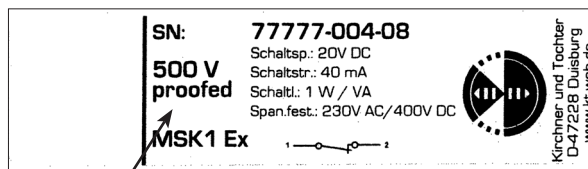

Warning!

This remark must be present on the label to be allowed to operate the equipment in the „Ex“ area!

4.3 Connection cable

The connection cable for the intrinsically safe electrical circuits is to be selected according to the valid installation standard (e. g. EN 60079-14). Summed current generation between different, intrinsically safe electrical currents of the variable area flow meter is to be avoided.



4.4 Ground connector

The following illustration shows a principle sketch of the connection of the ground cable with the process line.

This ground cable must be connected with the process line before starting up equipment of type:

- RA 60 Ex/FA 60 Ex
- RA 65 Ex/FA 65 Ex
- RA 87 Ex/FA 87 Ex

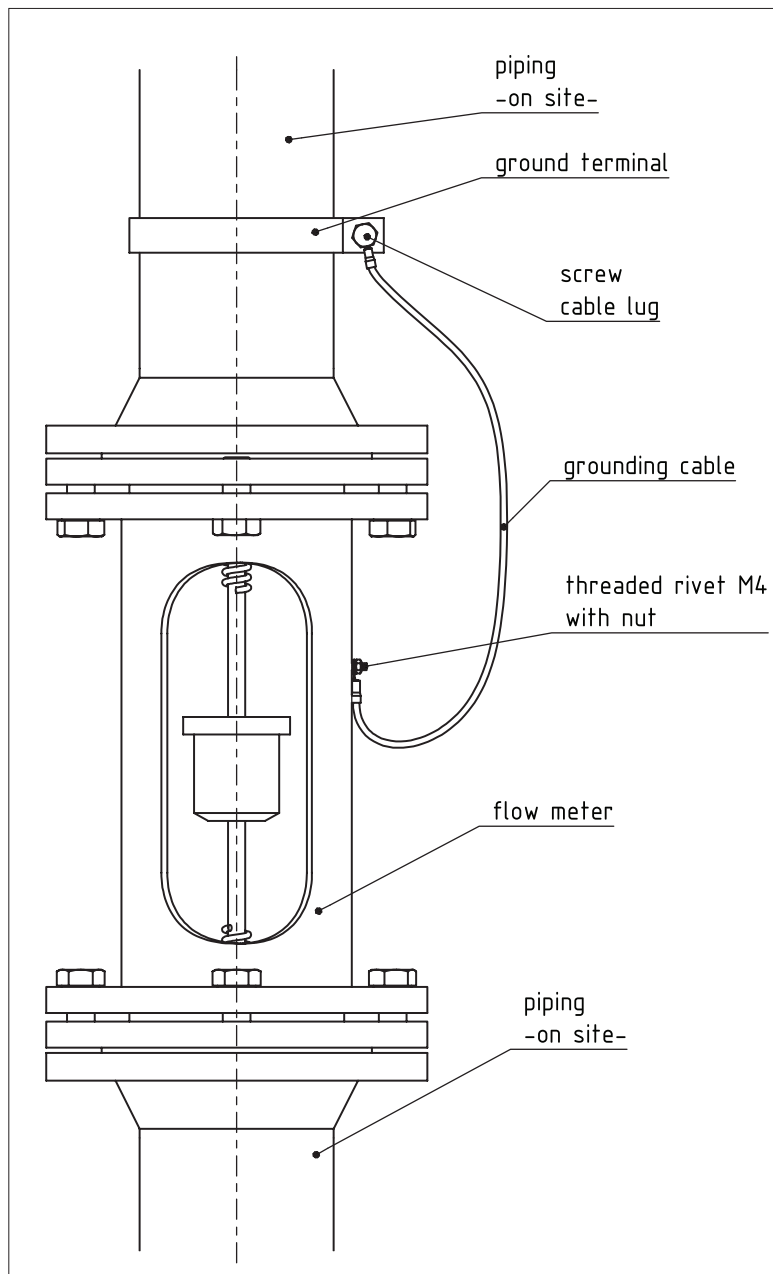



RA 60 Ex / FA 60 Ex
RA 65 Ex / FA 65 Ex
RA 87 Ex / FA 87 Ex

Variable area flow meters

5 Start-up

Before start-up, the following tests are to be performed:

1. Qualification testing for sufficient corrosion resistance to the measuring media of the materials used for measurement parts and the used sealing materials.
2. Connect the installed, intrinsically safe reed contacts correctly.
3. Electronically ground the measurement equipment. (Also see the illustration under section 4.4)
4. To prevent pressure surges, the operating company must ensure that the device is run with a continuous volume flow. (Do not use solenoid valves)

6 Service



Danger!

Danger of explosion can result from incorrect handling. The service of explosion protected operating material must only be performed by personnel trained in explosion protection.

The variable area flow meters of type:

- RA 60 Ex/FA 60 Ex
- RA 65 Ex/FA 65 Ex
- RA 87 Ex/FA 87 Ex

are maintenance free under normal operating conditions and proper usage.

In unfavourable operating modes, adverse measurement functions can occur due to soiling of the measuring glass or the variable area flow meter. In this case a cleaning of the measurement glass and the variable area flow meter is to be performed according to the installation and operating instructions. Alternatively, the device can be sent to Kirchner und Tochter for cleaning.



Systems in potentially explosive areas must be regularly inspected for their proper condition. The following tests must be performed regularly:

- Visual inspection of the housing, measurement glass and connection pieces for damage or corrosion.
- Check the measurement parts for leaks.
- Include the variable area flow meter in the regular pressure tests of the process line.
- Visual inspection of the variable area flow meter collectors (must be replaced if there is brittleness).
- Dust deposits on the equipment must not exceed a thickness of 3 mm.
- The equipment is to be thoroughly cleaned with a damp cloth.

7 Dismantling

7.1 Electrical connection

Disassembly should be performed with the power off if at all possible. If this is not possible, the basic conditions for intrinsic safety (e.g. no grounding or connection of different intrinsically safe electrical currents) must be observed during disassembly.

7.2 Process connections

Danger!

Danger of injury due to media escaping under pressure. The lines in which the variable area flow meter is installed are to be discharged before disassembly.



Depending on the medium, damage to the respiratory system or the skin may occur, for example. Uncontrolled discharge of residual liquid from the measurement piece is to be avoided.

For environmentally critical measuring media, all parts which have been in contact with the media are to be decontaminated carefully after removal. Removal and installation is the responsibility of the operating company.

8 Maintenance

Maintenance, which is relevant to safety in regards to explosion protection, is only to be performed by the manufacturer, their agents or supervised by authorised technicians.



RA 60 Ex / FA 60 Ex
 RA 65 Ex / FA 65 Ex
 RA 87 Ex / FA 87 Ex

Variable area flow meters

9 Annex

9.1 TÜV statement [Technical Control Board]

<p>Stellungnahme zur Anwendbarkeit der RL 94/9/EG (ATEX)</p> <p>Für Geräte und Komponenten zur Verwendung in explosionsgefährdeten Bereichen</p> <p>Statement for application of directive 94/9/EC</p> <p>for Equipment and Components intended for Use in Potentially Explosive Atmospheres</p>	
<p>Gegenstand: Gerät/Komponente Typ Subject: Equipment/Component type</p> <p>Hergestellt und zur Prüfung vorgelegt Manufactured and submitted for examination</p> <p>Anschrift Address</p> <p>Prüfgrundlage Basis for examination</p> <p>Verwendete Normen Standard basis</p> <p>Schutzartkennzeichen Code for type of protection</p> <p>Prüfergebnis: Examination result</p> <p>Prüfbericht-Nr: Assessment number</p> <p>TÜV Rheinland Industrie Service GmbH</p> <p> Friedhelm Risse Prüfer</p>	<p>Durchflussmessgeräte RA/FA 60, RA/FA 65, RA/FA 87</p> <p>A. Kirchner & Tochter</p> <p>Dieselstraße 17 D 47228 Duisburg</p> <p>Richtlinie 94/9/EG Directive 94/9/EC</p> <p>EN 1127-1:2007, EN 13463-1:2007,</p> <p>keine</p> <p>Die Geräte fallen nicht unter den Anwendungsbereich der Richtlinie 94/9/EG. Sie haben keine eigenen Zündquellen</p> <p>296/Ex653.00/08</p> <p>Essen, den 25.09.2008</p> <p> Stefanie Schwarz Prüferin</p>
<p>TÜV Rheinland Industrie Service GmbH Diese Stellungnahme darf nur vollständig und unverändert vervielfältigt werden. This statement may only be reproduced in its entirety and without change.</p>	

10203 10.05 © TÜV, TÜV und TÜV sind eingetragene Marken der TÜV Rheinland Group. Eine Nutzung und Verwendung bedarf der vorherigen Zustimmung durch die Unternehmen.



1) **Gegenstand und Typ**
Durchflussmessgeräte RA/FA 60, RA/FA 65 und RA/FA 87

2.) **Beschreibung und Bewertung**

Die Durchflussmessgeräte werden zum messen von Gasen und Flüssigkeiten nach dem Schwebekörperverfahren konzipiert. Dabei wird die Durchflussmenge durchströmender durchsichtiger Medien direkt an einem kalibrierten Borosilicat – Messkonus und einem auf schwimmenden Schwebekörper abgelesen.

Es können ungeführte Schwebekörper zum Einsatz gelangen sowie an einer konzentrisch montierten Edelstahlstange geführte Schwebekörper. Die Bewegung der Schwebekörper ist unter 1m/sec. Die Hubbewegung des Schwebekörpers wird nach oben und unten durch Dämpfungselemente begrenzt.

Die Ausführung der externen Anschlüsse ist beim Gerät RA als Rohrgewinde ausgeführt, während das Gerät FA für Flanschanschluss ausgeführt ist.

Die erforderlichen Dichtungen werden je nach Medium festgelegt.

Zwischen Messglas und Hülse ist eine Splitterschutz- Halbschale aus Acrylglas montiert. (Da das Acrylglas nicht leitfähig ist muss ein Hinweisschild angebracht werden „WARNUNG – GEFAHR DURCH ELEKTROSTATISCHE ENTLADUNG- SIEHE BETRIEBSANLEITUNG“)

An das Durchflussmessgerät kann ein Meldeschalter angebaut werden(Reedkontakt). Der Meldeschalter wird über ein Magnet im Schwebekörper betätigt. Der Meldeschalter muss über einen Bauartzugelassenen eigensichern Stromkreis geschaltet werden. Die Durchflussmessgeräte können in der Zone 1, Explosionsgruppe IIC eingesetzt werden.

3.) **Technische Daten**

Masszeichnung siehe Betriebsanleitung
Umgebungstemperatur - 20 bis +40°C
Betriebstemperatur max. 80 °C

Glasgröße	Max. Betriebsdruck In bar
9,5; 19; 30	10
36; 43	8
100 (nur bei RA/FA 60)	6
110 (nur bei RA/FA 60)	5
150 (nur bei RA/FA 60)	4
180 (nur bei RA/FA 60)	3

4.) **Prüfergebnis:**

Die im Kapitel 1 aufgeführte Durchflussmessgeräte fallen nicht in den Anwendungsbereich der Richtlinie 94/9/EG, da sie bei bestimmungsgemäßer Verwendung keine eigenen potentiellen Zündquellen besitzen.

TÜV Rheinland Industrie Service GmbH
Diese Stellungnahme darf nur vollständig und unverändert vervielfältigt werden.
This statement may only be reproduced in its entirety and without change.

9504_001X © TÜV TÜEV und TÜV sind eingetragene Marken. Eine Nutzung und Verwendung bedarf der vorherigen Zustimmung.



RA 60 Ex / FA 60 Ex
RA 65 Ex / FA 65 Ex
RA 87 Ex / FA 87 Ex

Variable area flow meters



5) ATEX Kennzeichnung

nicht erforderlich

6) Bedingungen für die sichere Verwendung bzw. Verwendungshinweise

Die Durchflussmessgeräte sind mit den Rohrleitungen auf ein Potential zubringen.

Die Hinweise des Herstellers sind zu sind einzuhalten.

TÜV Rheinland Industrie Service GmbH

Haumannplatz 4
45130 Essen

Essen, den 25.09.2008

Friedhelm Risse
Prüfer

Stefanie Schwarz
Prüferin

9504 05 06 © TÜV, TÜEV und TUV sind eingetragene Marken. Eine Nutzung und Verwendung bedarf der vorherigen Zustimmung

TÜV Rheinland Industrie Service GmbH

Diese Stellungnahme darf nur vollständig und unverändert vervielfältigt werden.
This statement may only be reproduced in its entirety and without change.



9.2 Declaration of conformity



Kirchner und Tochter
Durchflussmesstechnik seit 1951

CE EU-Konformitätserklärung
EU-Declaration of Conformity

A. Kirchner & Tochter GmbH, Dieselstr. 17, 47228 Duisburg, Deutschland

Wir erklären hiermit unter alleiniger Verantwortung, dass folgende Produkte
We declare herewith under sole responsibility that the products

RA 60 / FA 60 / RA 65 / FA65 / RA 87 / FA 87 / ... Ex
Schwabekörper-Durchflussmessgerät / Variable Area Flow meter

konform sind mit den Schutzzielen der Richtlinien des Europäischen Parlaments (soweit zutreffend).
are in conformity with the protection requirements of Council Directives (as far as applicable).

Der geforderte Sicherheits- und Gesundheitsschutz wird erfüllt in Übereinstimmung mit den harmonisierten Standards oder den angeführten technischen Normen (soweit zutreffend):
The stipulated safety and public health safety requirements are fulfilled in accordance with the harmonized standards or mentioned technical specifications (as far as applicable):

Richtlinie / Directive		Harmonisierte Normen/ Harmonized standards	Angewendete nationale Normen und Vorschriften/ Applied national standards and specifications
2014/68/EU	Druckgeräterichtlinie Pressure Equipment Directive	EN 12266-1:2012-06	AD-Merkblätter B0, N4

Laut Stellungnahme zur Anwendbarkeit der RL 94/9/EG des TÜV Rheinland fallen die Geräte nicht unter den Anwendungsbereich der Richtlinie 94/9/EG (ATEX) bzw. 2014/34/EU. Sie haben keine eigenen Zündquellen. Laut Prüfbericht des TÜV Rheinland mit der Nr. 296/Ex653.00/08 vom 25.09.2008, zur Anwendbarkeit der RL 94/9/EG, dürfen die oben genannten Geräte in Zone 1, Explosionsgruppe IIC eingesetzt werden.

According to the opinion on applicability of the Directive 94/9/EC by the TÜV Rheinland, the devices do not fall under the scope of Directive 94/9/EC (ATEX) resp. 2014/34/EU. They have no own sources of ignition. According to the test report of TÜV Rheinland with the No. 296/Ex653.00/08 from 25.09.2008, to the applicability of Directive 94/9/EC, the devices mentioned above may be used in Zone 1, explosion group IIC.

Die Kennzeichnung des Gerätes enthält entsprechend den zutreffenden Richtlinien folgende Angaben:
The equipment type plates contain due to these directives the following:

Richtlinie/ Directive	Konformitäts- bewertung/ Assessment	Kennzeichnung / Marking			
		Registrier Nr./ EC Type Approval	Kategorie/ Category	Benannte Stelle/ Notified body	Nr./ No.
2014/68/EU	A2	CE-0085BN0045	I & II	DVGW	CE 0085
	Art. 4.3 SEP	-	Art 4.3	-	-

Duisburg, 21.09.2016

Torsten Krawczyk
Geschäftsführer/
Managing Director

i.V. Stanislaw Wosmiller
Konstruktion/
Engineering

A. Kirchner & Tochter GmbH
Fon: +49 2065 9609-0 · Fax: +49 2065 9609-22
Geschäftsführende Gesellschafterin: Almuth Anne Römer
Amtsgericht Duisburg

Dieselstr. 17 · D-47228 Duisburg
www.kt-flow.de · info@kt-flow.de
Geschäftsführer: Torsten Krawczyk
HR B 6458



RA 60 Ex / FA 60 Ex
RA 65 Ex / FA 65 Ex
RA 87 Ex / FA 87 Ex

Variable area flow meters

Notes



RA 60 Ex / FA 60 Ex
RA 65 Ex / FA 65 Ex
RA 87 Ex / FA 87 Ex

Variable area flow meters

Notes



Kirchner und Tochter
Durchflussmesstechnik seit 1951



The devices from **Kirchner und Tochter** have been tested in compliance with applicable EC/EU CE-regulations of the European Community.

The respective declaration of conformity is available on request. Subject to change without notice. The current valid version of our documents can be found at www.kt-flow.de.

The **Kirchner und Tochter** QM-System is certified in accordance with DIN EN ISO 9001:2015. The quality is systematically adapted to the continuously increasing demands.